

New England Retail Price List



Tel: 01823 668428 Fax: 01823 668420 Email: [info@somercourt.co.uk](mailto:info@somercourt.co.uk)

## Designed with flexibility in mind, offering you everything you require in a corporate office environment.

Receptiv offers a full complement of reception furniture, consisting of modular base and counter units, supplied in various sizes and finishes with accessories such as paper storage, CD racks and key lockers available as optional extras.

Low-level glass shelves on steel supports offer a more open and inviting approach to the desk. Specific modules allowing for wheelchair access, accommodating the DDA requirements are also available. A cable management facility is incorporated into desk tops and panel legs with the use of cable ports. Cable trays are also available as an additional option.

A CAD planning facility is available free of charge. Please ask for details.

### Finishes available:

#### 25mm thick melamine faced chipboard (MFC) with 2mm thick PVC edging

• Ash	J	• Canadian Maple	CM
• Apple	A	• Walnut	N
• Cherry	C	• White	W
• Beech	B	• Silver	S
• Oak	O	• Santiago Cherry	SC

#### 3mm thick MDF laminated double sided modesty panels

• Ash	J	• Silver	S
• Apple	A	• Mirror	M
• Cherry	C	• Canadian Maple	CM
• Beech	B	• Walnut	N
• Oak	O	• White	W
• Santiago Cherry	SC		

### 800 deep and 600 deep variations available

Please follow the relevant steps when ordering to avoid errors. See example shown below:

**Product code:** 2005.RH.JS

**Product description:** Base unit supplied with one RH out-back leg 1600 x 800 x 727 Japanese Ash c/w silver modesty panel.

**Product code:** 2005.RH.JS

**Individual product:** RH = Right Hand J = Wood Finishes (MFC) – Japanese Ash  
LH = Left Hand S = Panel Finish (MDF) – Silver

Should you wish to accessorize Receptiv with pedestals, cable management trays, links and/or storage items for your reception, please refer to our **qudos** brochure and price list.

Combination of colour options available in the Receptiv range are shown below with the use of top and base units.

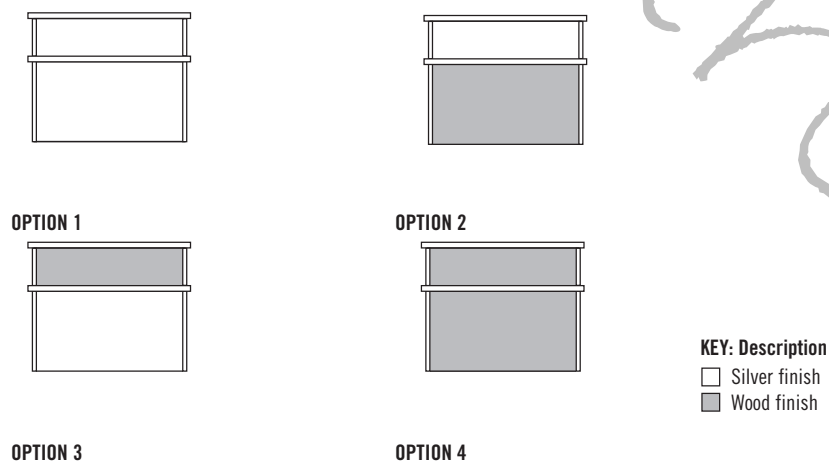

Should you decide to order a 600 deep base unit, please ensure to add (-6) to the general product code.  
 Example: 2005-6-RH-JS

PRODUCT CODES

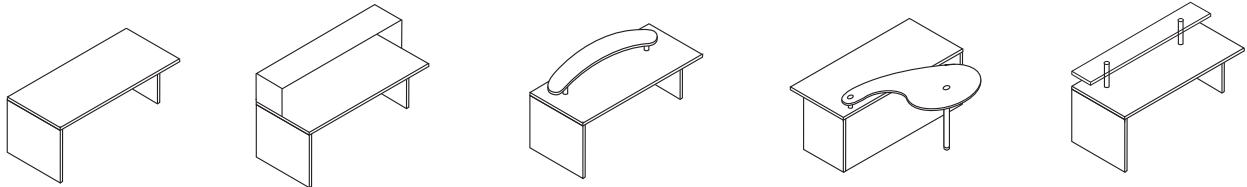

**CODE: (5)000**

**Five (5)** represents base unit to accommodate an executive glass shelf on brushed steel shelf supports. (RH shown)

*Handwritten scribbles in grey ink.*

BASE UNITS - 1 CUT-BACK LEG

1001(-6)	800	800(600)	727	<b>297</b>
2001(-6)	800	800(600)	727	<b>319</b>
3001(-6)	800	800(600)	727	<b>319</b>
5001(-6)	800	800(600)	727	<b>319</b>
1002(-6)	1000	800(600)	727	<b>311</b>
2002(-6)	1000	800(600)	727	<b>333</b>
3002(-6)	1000	800(600)	727	<b>333</b>
5002(-6)	1000	800(600)	727	<b>333</b>
1003(-6)	1200	800(600)	727	<b>326</b>
2003(-6)	1200	800(600)	727	<b>347</b>
3003(-6)	1200	800(600)	727	<b>347</b>
4003	1200	800	727	<b>347</b>
5003(-6)	1200	800(600)	727	<b>347</b>
1004(-6)	1400	800(600)	727	<b>339</b>
2004(-6)	1400	800(600)	727	<b>361</b>
3004(-6)	1400	800(600)	727	<b>361</b>
4004	1400	800	727	<b>361</b>
5004(-6)	1400	800(600)	727	<b>361</b>
1005(-6)	1600	800(600)	727	<b>361</b>
2005(-6)	1600	800(600)	727	<b>382</b>
3005(-6)	1600	800(600)	727	<b>382</b>
4005	1600	800	727	<b>382</b>
5005(-6)	1600	800(600)	727	<b>382</b>
1006(-6)	1800	800(600)	727	<b>382</b>
2006(-6)	1800	800(600)	727	<b>403</b>
3006(-6)	1800	800(600)	727	<b>403</b>
4006	1800	800	727	<b>403</b>
5006(-6)	1800	800(600)	727	<b>403</b>

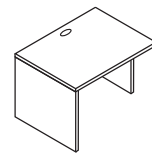

(RH shown)

Base unit supplied with one L/H or R/H cut-back leg. 800mm or 600mm deep.

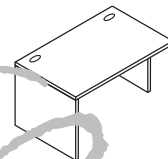

(RH shown)

Base unit supplied with one L/H or R/H cut-back leg. 800mm or 600mm deep.

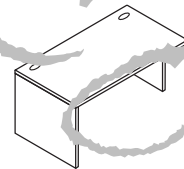

(RH shown)

Base unit supplied with one L/H or R/H cut-back leg. 800mm or 600mm deep.

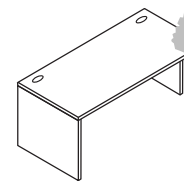

(RH shown)

Base unit supplied with one L/H or R/H cut-back leg. 800mm or 600mm deep.

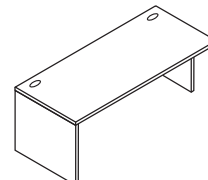

(RH shown)

Base unit supplied with one L/H or R/H cut-back leg. 800mm or 600mm deep.

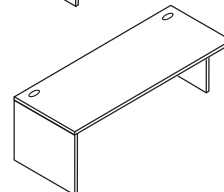

(RH shown)

Base unit supplied with one L/H or R/H cut-back leg. 800mm or 600mm deep.

LH = Left hand RH= Right hand

Add (-6) for 600 deep base units

## BASE UNITS - 1 CUT-BACK LEG

### CODE: (1)000

Base unit only, without top unit or shelves.

### CODE: (2)000

Base unit to accommodate top unit.

### CODE: (3)000

Base unit to accommodate a shaped MFC or glass shelf on steel supports.

### CODE: (4)000

Base unit 1200(W), 1400(W), 1600(W), and 1800(W) to accommodate mobile rotating shelf unit.

#### Description

#### Code

#### W x D x H

#### Price £

Base corner unit @ 90° with 800mm radius supplied with one LH or RH cut-back leg. (LH shown) 800mm or 600mm deep.

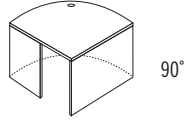

1051(-6)	800	800(600)	727	481
2051(-6)	800	800(600)	727	502
3051(-6)	800	800(600)	727	502
5051(-6)	800	800(600)	727	502

Base corner unit @ 90° with 1200mm radius supplied with one LH or RH cut-back leg. (LH shown) 800mm or 600mm deep.

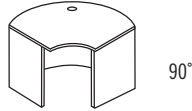

1052(-6)	1700	800(600)	727	622
2052(-6)	1700	800(600)	727	643
3052(-6)	1700	800(600)	727	643
5052(-6)	1700	800(600)	727	643

Radius base unit @ 60° with 800mm ends supplied with one LH or RH cut-back leg. (RH shown) 800mm or 600mm deep.

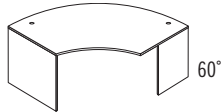

1053(-6)	1800	800(600)	727	715
2053(-6)	1800	800(600)	727	739
3053(-6)	1800	800(600)	727	739
5053(-6)	1800	800(600)	727	739

Radius base unit INVERTED @ 60° with 800mm ends supplied with one LH or RH cut-back leg. (RH shown) 800mm or 600mm deep.



1054(-6)	1800	800(600)	727	737
2054(-6)	1800	800(600)	727	762
3054(-6)	1800	800(600)	727	762
5054(-6)	1800	800(600)	727	762

Base segment unit @ 30° with 800mm ends supplied with one LH or RH cut-back leg. (LH shown) 800mm or 600mm deep.

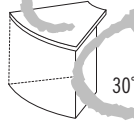

1055(-6)	880	800(600)	727	465
2055(-6)	880	800(600)	727	484

Base segment unit INVERTED @ 30° with 800mm ends supplied with one LH or RH cut-back leg. (LH shown) 800mm or 600mm deep.

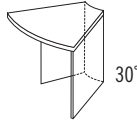

1056(-6)	880	800(600)	727	479
2056(-6)	880	800(600)	727	500

Radius base unit @ 45° with 800mm ends supplied with one LH or RH cut back leg. (RH shown) 800mm or 600mm deep.

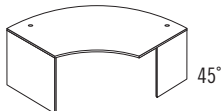

1057(-6)	1530	800(600)	727	591
2057(-6)	1530	800(600)	727	611
3057(-6)	1530	800(600)	727	611
5057(-6)	1530	800(600)	727	611

Radius base unit INVERTED @ 45° with 800mm ends supplied with one LH or RH cut back leg. (RH shown) 800mm or 600mm deep.

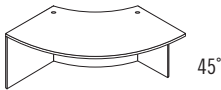

1058(-6)	1530	800(600)	727	680
2058(-6)	1530	800(600)	727	702
3058(-6)	1530	800(600)	727	702
5058(-6)	1530	800(600)	727	702

Base segment unit @ 22° with one RH or LH cut-back leg (LH shown) 800mm or 600mm deep.

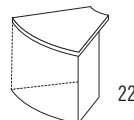

1059(-6)	780	800(600)	727	450
2059(-6)	780	800(600)	727	471

Base segment unit INVERTED @ 22° with one RH or LH cut-back leg (LH shown) 800mm or 600mm deep.

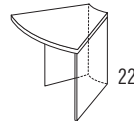

1060(-6)	780	800(600)	727	465
2060(-6)	780	800(600)	727	484

**CODE: (5)000**

Base unit to accommodate an executive glass shelf on brushed steel supports.

**BASE UNITS - 2 CUT-BACK LEGS**

Code	W	x	D	x	H	Price £	Description
1007(-6)	800	800(600)	727			297	Base unit supplied with two cut-back legs 800mm or 600mm deep.
2007(-6)	800	800(600)	727			319	
3007(-6)	800	800(600)	727			319	
5007(-6)	800	800(600)	727			319	
1008(-6)	1000	800(600)	727			311	Base unit supplied with two cut-back legs 800mm or 600mm deep.
2008(-6)	1000	800(600)	727			333	
3008(-6)	1000	800(600)	727			333	
5008(-6)	1000	800(600)	727			333	
1009(-6)	1200	800(600)	727			326	Base unit supplied with two cut-back legs 800mm or 600mm deep.
2009(-6)	1200	800(600)	727			347	
3009(-6)	1200	800(600)	727			347	
4009	1200	800	727			347	
5009(-6)	1200	800(600)	727			347	
1010(-6)	1400	800(600)	727			339	Base unit supplied with two cut-back legs 800mm or 600mm deep.
2010(-6)	1400	800(600)	727			361	
3010(-6)	1400	800(600)	727			361	
4010	1400	800	727			361	
5010(-6)	1400	800(600)	727			361	
1011(-6)	1600	800(600)	727			361	Base unit supplied with two cut-back legs 800mm or 600mm deep.
2011(-6)	1600	800(600)	727			382	
3011(-6)	1600	800(600)	727			382	
4011	1600	800	727			382	
5011(-6)	1600	800(600)	727			382	
1012(-6)	1800	800(600)	727			382	Base unit supplied with two cut-back legs 800mm or 600mm deep.
2012(-6)	1800	800(600)	727			403	
3012(-6)	1800	800(600)	727			403	
4012	1800	800	727			403	
5012(-6)	1800	800(600)	727			403	
1015(-6)	1600	1200	727			515	Base unit radial workstation with cut-back leg. Specify LH or RH. (RH shown) 800mm units (1015) to have a 800mm end and a 600mm return end. 600mm units (1015-6) to have two 600mm ends.
2015(-6)	1600	1200	727			537	
3015(-6)	1600	1200	727			537	
4015	1600	1200	727			537	
5015(-6)	1600	1200	727			537	
1016(-6)	1800	1200	727			572	Base unit radial workstation with cut-back leg. Specify LH or RH. (RH shown) 800mm units (1016) to have a 800mm end and a 600mm return end. 600mm units (1016-6) to have two 600mm ends.
2016(-6)	1800	1200	727			592	
3016(-6)	1800	1200	727			592	
4016	1800	1200	727			592	
5016(-6)	1800	1200	727			592	
1017(-6)	800	800(600)	727			481	Base corner unit @ 90° with 800mm radius, cut-back legs and 800mm or 600mm deep.
2017(-6)	800	800(600)	727			502	
3017(-6)	800	800(600)	727			502	
5017(-6)	800	800(600)	727			502	
1018(-6)	1700	800(600)	727			622	Base corner unit @ 90° with 1200mm radius, cut-back legs and 800mm or 600mm deep.
2018(-6)	1700	800(600)	727			643	
3018(-6)	1700	800(600)	727			643	
5018(-6)	1700	800(600)	727			643	
1073	1000	800(600)	727			339	Wave base unit with two cut back legs. Specify LH or RH (RH shown)
2073	1000	800(600)	727			347	
3073	1000	800(600)	727			347	
5073	1000	800(600)	727			347	

## BASE UNITS - 2 CUT-BACK LEGS

### CODE: (1)000

Base unit only, without top unit or shelves.

### CODE: (2)000

Base unit to accommodate top unit.

### CODE: (3)000

Base unit to accommodate a shaped MFC or glass shelf on steel supports.

### CODE: (4)000

Base unit 1200(W), 1400(W), 1600(W), and 1800(W) to accommodate mobile rotating shelf unit.

Base corner unit @ 45° with 800mm radius, cut-back legs 800mm or 600mm deep.

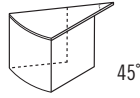

1019(-6)	610	800(600)	727	<b>382</b>
2019(-6)	610	800(600)	727	<b>403</b>

Base corner unit @ 45° with 1200mm radius, cut-back legs 800mm or 600mm deep.

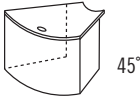

1020(-6)	920	800(600)	727	<b>495</b>
2020(-6)	920	800(600)	727	<b>515</b>

Base corner unit with 1200mm radius inverted with cut-back legs, centre leg 800mm or 600mm deep.



1021(-6)	1700	800(600)	727	<b>643</b>
2021(-6)	1700	800(600)	727	<b>664</b>
3021(-6)	1700	800(600)	727	<b>664</b>
5021(-6)	1700	800(600)	727	<b>664</b>

Base unit with horizontal and vertical hatch doors and latch. Two full P-End legs 800mm or 600mm deep.

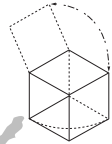

1022	800	800	727	<b>333</b>
1022(-6)	600	600	727	<b>333</b>
1022(-86)	800	600	727	<b>333</b>

Radius base unit @ 60° with two cut back legs 800mm or 600mm deep.



1061(-6)	1800	800(600)	727	<b>715</b>
2061(-6)	1800	800(600)	727	<b>739</b>
3061(-6)	1800	800(600)	727	<b>739</b>
5061(-6)	1800	800(600)	727	<b>739</b>

Radius base unit INVERTED @ 60° with two cut back legs 800mm or 600mm deep.



1062(-6)	1800	800(600)	727	<b>737</b>
2062(-6)	1800	800(600)	727	<b>762</b>
3062(-6)	1800	800(600)	727	<b>762</b>
5062(-6)	1800	800(600)	727	<b>762</b>

Base segment unit @ 30° with two cut back legs 800mm or 600mm deep.



1063(-6)	880	800(600)	727	<b>465</b>
2063(-6)	880	800(600)	727	<b>484</b>

Base segment unit INVERTED @ 30° with two cut back legs 800mm or 600mm deep.



1064(-6)	880	800(600)	727	<b>479</b>
2064(-6)	880	800(600)	727	<b>500</b>

Radius base unit @ 45° with two cut back legs 800mm or 600mm deep.

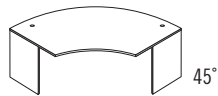

1065(-6)	1530	800(600)	727	<b>591</b>
2065(-6)	1530	800(600)	727	<b>611</b>
3065(-6)	1530	800(600)	727	<b>611</b>
5065(-6)	1530	800(600)	727	<b>611</b>

Radius base unit INVERTED @ 45° with two cut back legs 800mm or 600mm deep.

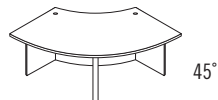

1066(-6)	1530	800(600)	727	<b>580</b>
2066(-6)	1530	800(600)	727	<b>702</b>
3066(-6)	1530	800(600)	727	<b>702</b>
5066(-6)	1530	800(600)	727	<b>702</b>

Base segment unit @ 22° with two cut back legs 800mm or 600mm deep.



1067(-6)	780	800(600)	727	<b>450</b>
2067(-6)	780	800(600)	727	<b>471</b>

Base segment unit INVERTED @ 22° with two cut back legs 800mm or 600mm deep.

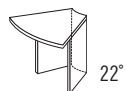

1068(-6)	780	800(600)	727	<b>465</b>
2068(-6)	780	800(600)	727	<b>484</b>

**CODE: (5)000**

Base unit to accommodate an executive glass shelf on brushed steel supports.

**BASE UNITS - TWO FULL P-END LEGS**

1030(-6)	800	800(600)	727	<b>297</b>
2030(-6)	800	800(600)	727	<b>319</b>
3030(-6)	800	800(600)	727	<b>319</b>
5030(-6)	800	800(600)	727	<b>319</b>
1031(-6)	1000	800(600)	727	<b>311</b>
2031(-6)	1000	800(600)	727	<b>333</b>
3031(-6)	1000	800(600)	727	<b>333</b>
5031(-6)	1000	800(600)	727	<b>333</b>
1032(-6)	1200	800(600)	727	<b>326</b>
2032(-6)	1200	800(600)	727	<b>347</b>
3032(-6)	1200	800(600)	727	<b>347</b>
4032	1200	800	727	<b>347</b>
5032(-6)	1200	800(600)	727	<b>347</b>
1033(-6)	1400	800(600)	727	<b>339</b>
2033(-6)	1400	800(600)	727	<b>361</b>
3033(-6)	1400	800(600)	727	<b>361</b>
4033	1400	800	727	<b>361</b>
5033(-6)	1400	800(600)	727	<b>361</b>
1034(-6)	1600	800(600)	727	<b>361</b>
2034(-6)	1600	800(600)	727	<b>382</b>
3034(-6)	1600	800(600)	727	<b>382</b>
4034	1600	800	727	<b>382</b>
5034(-6)	1600	800(600)	727	<b>382</b>
1035(-6)	1800	800(600)	727	<b>382</b>
2035(-6)	1800	800(600)	727	<b>403</b>
3035(-6)	1800	800(600)	727	<b>403</b>
4035	1800	800	727	<b>403</b>
5035(-6)	1800	800(600)	727	<b>403</b>
1013(-6)	1600	1200	727	<b>515</b>
2013(-6)	1600	1200	727	<b>537</b>
3013(-6)	1600	1200	727	<b>537</b>
4013	1600	1200	727	<b>537</b>
5013(-6)	1600	1200	727	<b>537</b>
1014(-6)	1800	1200	727	<b>572</b>
2014(-6)	1800	1200	727	<b>592</b>
3014(-6)	1800	1200	727	<b>592</b>
4014	1800	1200	727	<b>592</b>
5014(-6)	1800	1200	727	<b>592</b>
1069(-6)	1800	800(600)	727	<b>715</b>
2069(-6)	1800	800(600)	727	<b>739</b>
3069(-6)	1800	800(600)	727	<b>739</b>
5069(-6)	1800	800(600)	727	<b>739</b>
1070(-6)	1800	800(600)	727	<b>737</b>
2070(-6)	1800	800(600)	727	<b>762</b>
3070(-6)	1800	800(600)	727	<b>762</b>
5070(-6)	1800	800(600)	727	<b>762</b>
1071(-6)	1530	800(600)	727	<b>591</b>
2071(-6)	1530	800(600)	727	<b>611</b>
3071(-6)	1530	800(600)	727	<b>611</b>
5071(-6)	1530	800(600)	727	<b>611</b>
1072(-6)	1530	800(600)	727	<b>680</b>
2072(-6)	1530	800(600)	727	<b>702</b>
3072(-6)	1530	800(600)	727	<b>702</b>
5072(-6)	1530	800(600)	727	<b>702</b>

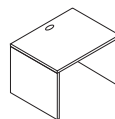

Base unit supplied with two full panel end legs 800mm or 600mm deep.

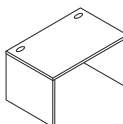

Base unit supplied with two full panel end legs 800mm or 600mm deep.

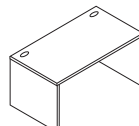

Base unit supplied with two full panel end legs 800mm or 600mm deep.

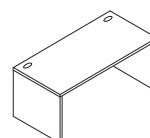

Base unit supplied with two full panel end legs 800mm or 600mm deep.

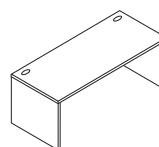

Base unit supplied with two full panel end legs 800mm or 600mm deep.

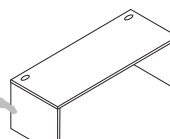

Base unit supplied with two full panel end legs 800mm or 600mm deep.

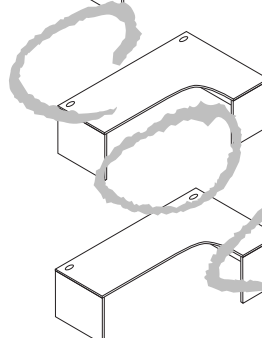

Base unit radial workstation with full panel end legs, please specify LH or RH. (RH shown) 800mm units (1013) to have one 800mm end and a 600mm return end. 600mm units (1013-6) to have two 600mm ends.



Base unit radial workstation with full panel end legs, please specify LH or RH. (RH shown) 800mm units (1014) to have one 800mm end and a 600mm return end. 600mm units (1014-6) to have two 600mm ends.

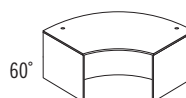

Radius base unit @ 60° with two full panel end legs 800mm or 600mm deep.

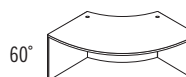

Radius base unit inverted @ 60° with two full panel end legs 800mm or 600mm deep.

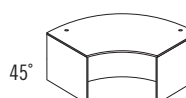

Radius base unit @ 45° with two full panel end legs 800mm or 600mm deep.



Radius base unit inverted @ 45° with two full panel end legs 800mm or 600mm deep.



**BASE UNITS -  
WITH RECESS FOR WHEEL CHAIR ACCESS**

Base unit supplied with two full panel end legs and recessed mod panel. (recessed 400mm)

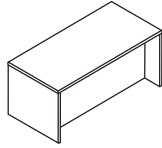

1040	1600	800	727	339
------	------	-----	-----	-----

Base unit radial workstation with full panel end legs and recessed mod panel. Please specify LH or RH. (LH shown) (recessed 400mm)

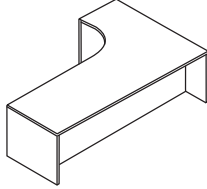

1041	1800	1200	727	572
------	------	------	-----	-----

Base unit supplied with one cut-back leg and recessed mod panel. (RH shown) (recessed 400mm)

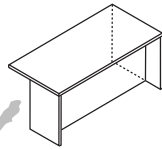

1042	1600	800	727	339
------	------	-----	-----	-----

Base unit radial workstation with one cut-back leg and recessed mod panel. Please specify LH or RH. (LH shown) (recessed 400mm)

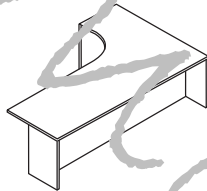

1043	1800	1200	727	572
------	------	------	-----	-----

Base unit supplied with two cut-back legs and recessed mod panel. (recessed 400mm)

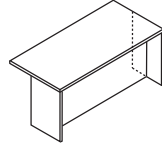

1044	1600	800	727	339
------	------	-----	-----	-----

Base corner unit @ 90° with 1200mm radius, with two cut-back legs and recessed mod panel. (recessed 400mm)

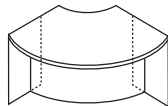

1045	1200	1200	727	622
------	------	------	-----	-----

Base corner unit @ 90° with 1200mm radius, with one cut-back leg and recessed mod panel. Specify LH or RH. LH shown.

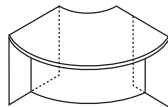

1046	1200	1200	727	622
------	------	------	-----	-----

Conference link with 300mm base.



1050(-6)	1000(800)	800(600)	727	426
----------	-----------	----------	-----	-----

Cutback base units are not 'STAND ALONE' units and must be anchored to other base units on 'CUT-BACK SIDE' for stability.

1101 800 350 465 198

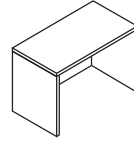

Top unit for reception base units.

1102 1000 350 465 213

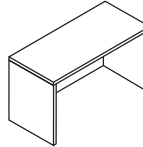

Top unit for reception base units.

1103 1200 350 465 226

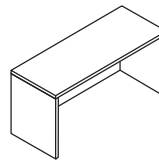

Top unit for reception base units.

1104 1400 350 465 240

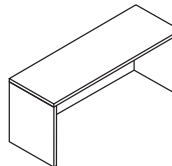

Top unit for reception base units.

1105 1600 350 465 256

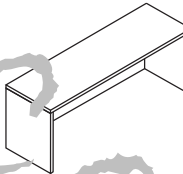

Top unit for reception base units.

1106 1800 350 465 275

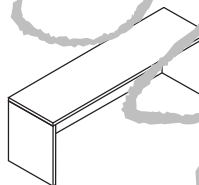

Top unit for reception base units.

1107 800 350 465 220

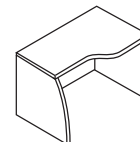

Top unit with wave cut-back for reception base unit. Please specify RH or LH. Cut back depth is 180mm. (RH shown)

1108 1000 350 465 235

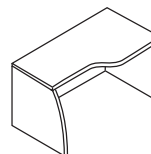

Top unit with wave cut-back for reception base unit. Please specify RH or LH. Cut back depth is 180mm. (RH shown)



TOP UNITS

Description

Top unit with wave cut-back for reception base unit. Please specify RH or LH. Cut back depth is 180mm. (RH shown)

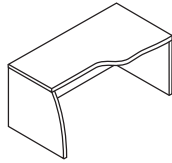

1109 1200 350 465 248

Top unit with wave cut-back for reception base unit. Please specify RH or LH. Cut back depth is 180mm. (RH shown)

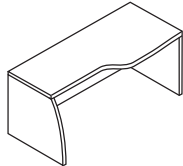

1110 1400 350 465 262

Top unit with wave cut-back for reception base unit. Please specify RH or LH. Cut back depth is 180mm. (RH shown)

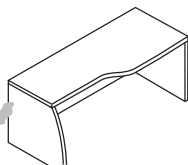

1111 1600 350 465 275

Top unit with wave cut-back for reception base unit. Please specify RH or LH. Cut back depth is 180mm. (RH shown)

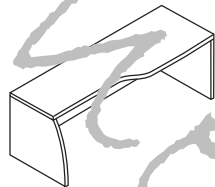

1112 1800 350 465 297

Top unit @ 90° with 800mm radius, 350mm deep. No accessories can be fitted.

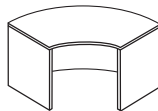

1113 800 800 465 275

Top unit @ 90° with 1200mm radius, 350mm deep. No accessories can be fitted.

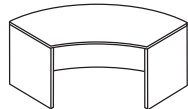

1114 1200 1200 465 333

Top unit @ 90° with 800mm radius 180mm deep. Compatible with all wave cut-back top units. No accessories can be fitted.

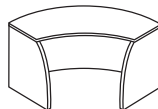

1115 800 800 465 220

Top unit @ 90° 1200mm radius, 350mm deep with cut-out. No accessories can be fitted.

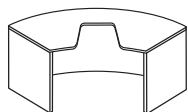

1116 1200 1200 465 361

1117 1200 1200 465 416

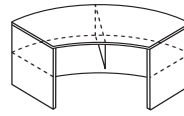

Top unit @ 90°, 1200mm radius with shelf, 350mm deep. No accessories can be fitted.

1118 800 800 465 347

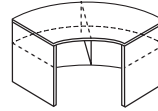

Top unit @ 90°, 800mm radius with shelf, 350mm deep. No accessories can be fitted.

1119 612 350 465 220



Top unit @ 45° with 800mm radius, 350mm deep. No accessories can be fitted.

1120 612 180 465 178



Top unit @ 45° with 800mm radius, 180mm deep. Compatible with all wave cut-back top units. No accessories can be fitted.

1121 918 180 465 270

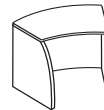

Top unit @ 45° with 1200mm radius, 180mm deep. Compatible with all wave cut-back top units. No accessories can be fitted.

1122 918 350 465 220

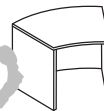

Top unit @ 45° with 1200mm radius, 350mm deep. No accessories can be fitted.

1123 918 350 465 333

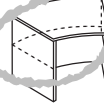

Top unit @ 45°, 1200mm radius with shelf, 350mm deep. No accessories can be fitted.

1124 612 350 465 275

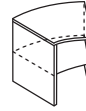

Top unit @ 45°, 800mm radius with shelf, 350mm deep. No accessories can be fitted.

1125 1061 350 465 275

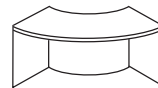

Top unit @ 90° 350mm deep INVERTED. No accessories can be fitted.

1139 820 180 465 325

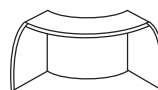

Top unit @ 90° 180mm deep INVERTED. No accessories can be fitted.

TOP UNITS

Description

Top unit @ 60°  
No accessories can be fitted.



1140 1800 350 465 382

Top unit @ 60° with fixed shelf.  
No accessories can be fitted.

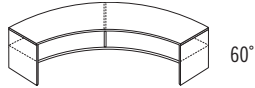

1141 1800 350 465 478

Top unit @ 60° INVERTED.  
No accessories can be fitted.



1142 1800 350 465 317

Top unit @ 60° INVERTED  
with fixed shelf.  
No accessories can be fitted.

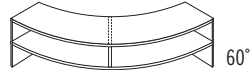

1143 1800 350 465 395

Top unit segment @ 30°  
No accessories can be fitted.



1144 880 350 465 220

Top unit segment @ 30° INVERTED.  
No accessories can be fitted.



1145 880 350 465 255

Top unit @ 45°  
No accessories can be fitted



1146 1530 350 465 363

Top unit @ 45° with fixed shelf.  
No accessories can be fitted.

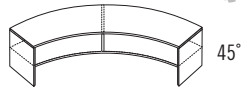

1147 1530 350 465 345

Top unit @ 45°INVERTED.  
No accessories can be fitted

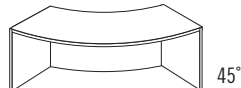

1148 1530 350 465 302

Top unit @ 45°INVERTED  
with fixed shelf.  
No accessories can be fitted.

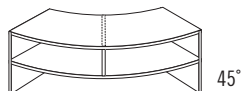

1149 1530 350 465 377

Top unit segment @ 22°  
No accessories can be fitted.



1150 780 350 465 215

Top unit segment @ 22°INVERTED.  
No accessories can be fitted.



1151 780 350 465 248

1131 800 420 230 198

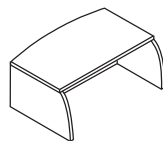

Shallow top units for reception base units. No accessories can be fitted.

1132 1000 420 230 213

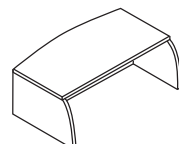

Shallow top units for reception base units. No accessories can be fitted.

1133 1200 420 230 226

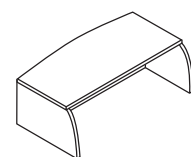

Shallow top units for reception base units. No accessories can be fitted.

1134 1400 420 230 240

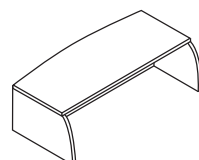

Shallow top units for reception base units. No accessories can be fitted.

1135 1600 420 230 256

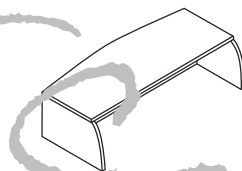

Shallow top units for reception base units. No accessories can be fitted.

1136 1800 420 230 275

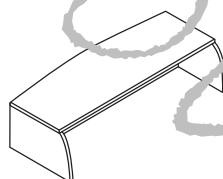

Shallow top units for reception base units. No accessories can be fitted.

1137 800 880 230 275



Shallow top units @ 90° with 800mm radius, 420mm deep. No accessories can be fitted.

1138 1200 1200 230 333



Shallow top units @ 90° with 1200mm radius, 420mm deep. No accessories can be fitted.

SHAPED MFC OR GLASS SHELVES

Description

Fixed bowed reception shelf (silver) MFC or glass, clear or frosted on steel supports.



for 800mm base unit and 1200mm radius inverted base unit (3021)

1301 (S)	600	300	225	157
1301 (C)	600	300	225	472
1301 (F)	600	300	225	472

Fixed bowed reception shelf (silver) MFC or glass, clear or frosted on steel supports.



for 1000mm base unit and 45° inverted radius base unit (3058/3066/3072)

1302 (S)	800	300	225	170
1302 (C)	800	300	225	489
1302 (F)	800	300	225	489

Fixed bowed reception shelf (silver) MFC or glass, clear or frosted on steel supports.



for 1200mm base unit and 60° inverted radius base unit (3054/3062/3070)

1303 (S)	900	300	225	178
1303 (C)	900	300	225	506
1303 (F)	900	300	225	506

Fixed bowed reception shelf (silver) MFC or glass, clear or frosted on steel supports.



(for 1400mm base unit)

1304 (S)	1000	300	225	185
1304 (C)	1000	300	225	523
1304 (F)	1000	300	225	523

Fixed bowed reception shelf (silver) MFC or glass, clear or frosted on steel supports.



for 1600mm base unit and 45° radius base unit (3057/3065/3071)

1305 (S)	1200	300	225	198
1305 (C)	1200	300	225	540
1305 (F)	1200	300	225	540

Fixed bowed reception shelf (silver) MFC or glass, clear or frosted on steel supports.



for 1800mm base unit and 60° radius base unit (3053/3061/3069)

1306 (S)	1400	300	225	213
1306 (C)	1400	300	225	581
1306 (F)	1400	300	225	581

Fixed 90° corner reception shelf (silver) MFC or glass, clear or frosted on steel supports.



(for 800mm corner units)

1307 (S)	800	800	225	198
1307 (C)	800	800	225	540
1307 (F)	800	800	225	540

Fixed 90° corner reception shelf (silver) MFC or glass, clear or frosted on steel supports.

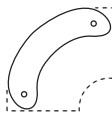

(for 1200mm corner units)

1308 (S)	1200	1200	225	226
1308 (C)	1200	1200	225	752
1308 (F)	1200	1200	225	752

(S) = Silver (C) = Clear (F) = Frosted

1501 (C)	796	350	210	<b>473</b>
1501 (F)	796	350	210	<b>473</b>



800mm Rectangular Glass Shelf to suit 800mm base unit  
 5001 (-6) - with 1 cut back leg  
 5007 (-6) - with 2 cut back legs  
 5030 (-6) - with 2 full legs

1502 (C)	996	350	210	<b>489</b>
1502 (F)	996	350	210	<b>489</b>



1000mm Rectangular Glass Shelf to suit 1000mm base unit  
 5002 (-6) - with 1 cut back leg  
 5008 (-6) - with 2 cut back legs  
 5031 (-6) - with 2 full legs  
 5073 (-6) - with 2 cut back legs

1503 (C)	1196	350	210	<b>504</b>
1503 (F)	1196	350	210	<b>504</b>



1200mm Rectangular Glass Shelf to suit 1200mm base unit  
 5003 (-6) - with 1 cut back leg  
 5009 (-6) - with 2 cut back legs  
 5032 (-6) - with 2 full legs

1504 (C)	1396	350	210	<b>522</b>
1504 (F)	1396	350	210	<b>522</b>



1400mm Rectangular Glass Shelf to suit 1400mm base unit  
 5004 (-6) - with 1 cut back leg  
 5010 (-6) - with 2 cut back legs  
 5033 (-6) - with 2 full legs

1505 (C)	1596	350	210	<b>541</b>
1505 (F)	1596	350	210	<b>541</b>



1600mm Rectangular Glass Shelf to suit 1600mm base unit  
 5005 (-6) - with 1 cut back leg  
 5011 (-6) - with 2 cut back legs  
 5034 (-6) - with 2 full legs  
 5013 (-6) - radial with full legs  
 5015 (-6) - radial with 1 cut back leg

1506 (C)	1796	350	210	<b>580</b>
1506 (F)	1796	350	210	<b>580</b>

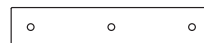

1800mm Rectangular Glass Shelf to suit 1800mm base unit  
 5006 (-6) - with 1 cut back leg  
 5012 (-6) - with 2 cut back legs  
 5035 (-6) - with 2 full legs  
 5014 (-6) - radial with full legs  
 5016 (-6) - radial with 1 cut back leg

GLASS SHELVES & MOBILE SHELVES

Description

90 Deg 800 Rad Glass to suit  
90 Deg base unit  
5017-(6) - with 2 cut back legs  
5051-(6) - with 1 cut back leg

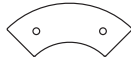

1507 (C)	1120	476	210	541
1507 (F)	1120	476	210	541

90 Deg 1200 Rad Glass to suit  
1200mm Rad 90 Deg base unit  
5018-(6) - with 2 cut back legs  
5052-(6) - with 1 cut back leg



1508 (C)	1686	593	210	751
1508 (F)	1686	593	210	751

90 Deg Inverted 800 Rad Glass to suit  
800mm Rad 90 Deg Inverted base unit  
5021-(6) - with 2 cut back legs



1509 (C)	1049	462	210	541
1509 (F)	1049	462	210	541

60 Deg Glass to suit 60 Deg base unit  
5053-(6) - with 1 cut back leg  
5061-(6) - with 2 cut back legs  
5069-(6) - with 2 full legs



1510 (C)	1789	543	210	751
1510 (F)	1789	543	210	751

60 Deg Inverted Glass to suit  
60 Deg Inverted base unit  
5054-(6) - with 1 cut back leg  
5062-(6) - with 2 cut back legs  
5070-(6) - with 2 full legs



1511 (C)	1339	479	210	594
1511 (F)	1339	479	210	594

45 Deg Glass to suit 45 Deg base unit  
5057-(6) - with 1 cut back leg  
5065-(6) - with 2 cut back legs  
5071-(6) - with 2 full legs



1512 (C)	1521	472	210	615
1512 (F)	1521	472	210	615

45 Deg Inverted Glass to suit  
45 Deg Inverted base unit  
5058-(6) - with 1 cut back leg  
5066-(6) - with 2 cut back legs  
5072-(6) - with 2 full legs



1513 (C)	1176	438	210	541
1513 (F)	1176	438	210	541

Mobile rotating shelf unit (silver) on  
steel support incorporating tubular  
leg and castor.



(for 1200mm BU, L/H shown)

1401	1065	540	954	206
------	------	-----	-----	-----

Mobile rotating shelf unit (silver) on  
steel support incorporating tubular  
leg and castor.



(for 1400mm BU, L/H shown)

1402	1275	590	954	220
------	------	-----	-----	-----

Mobile rotating shelf  
unit (silver) on steel  
support incorporating  
tubular leg and castor.



(for 1600mm BU, L/H shown)

1403	1465	640	954	235
------	------	-----	-----	-----

Mobile rotating shelf  
unit (silver) on steel  
support incorporating  
tubular leg and castor.



(for 1800mm BU, L/H shown)

1404	1665	685	954	248
------	------	-----	-----	-----

1201	556	160	216	85
1202	556	320	216	114
1203	556	320	216	150
1204	556	160	168	114
1205	556	160	216	150
1210	465	575	690	275
1211	405	600	727	34
2211	405	600	727	32
1213	405	800	727	396
2213	405	800	727	442
1214	405	350	465	171
EMP 25	423	500	568	183
EMP 35	423	500	568	183
XP-M3M	400	575	580	259

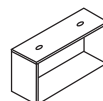

160mm deep **shelf unit** to fit inside top-unit.

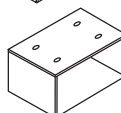

320mm deep **shelf unit** to fit inside top-unit.

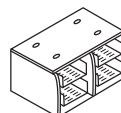

**Tray unit** with 4 pull-out trays to fit inside top-unit.

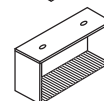

**CD-unit** to fit inside top-unit.

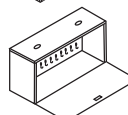

**Key-unit** to fit inside top-unit (18 hooks-lockable).

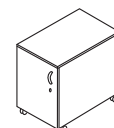

Mobile storage unit to slide under base unit (with one adjustable shelf).

(R/H shown)

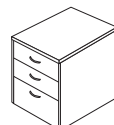

Desk height pedestal 36 with back to match receptiv base units.

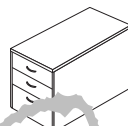

Desk height pedestal 38 with back to match receptiv base units.

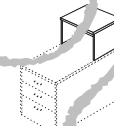

Top unit for receptiv desk height pedestal units (pedestal not included).

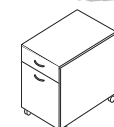

Mobile pedestal for 600 deep base units.

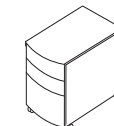

Mobile metal pedestal 3 drawer and heavy duty in silver Ral 9006 includes pen tray.

## RECEPTION TABLES

### Description

Circular table with tapered silver legs.



5101

550

550

400

262

Circular table with curtain leg.



5201

550

550

400

275

Elliptical table with tapered silver legs.



5102

1000

500

400

297

Elliptical table with curtain leg.



5202

1000

500

400

311

Square table with tapered silver legs.



5103

550

550

400

275

Square table with curtain leg.



5203

550

550

400

291

Kidney table with tapered silver legs.



5104

1020

570

400

305

Kidney table with curtain leg.



5204

1020

570

400

319

Triangular table with tapered silver legs.



5105

635

635

400

275

Triangular table with curtain leg.



5205

635

635

400

291

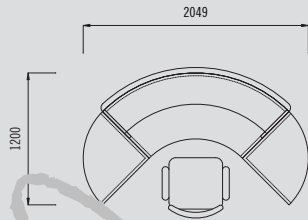

**ALTERNATIVE 1 - 600MM DEEP**

The new 600mm deep base units give us the opportunity to provide far more compact and space saving reception layouts.

This in turn makes our Receptiv Range more flexible and accommodating to virtually any requirements without having to pay for specially made receptions.

This option shows a wide radius segment base unit with radial storage units at either side. The base unit hosts a shallow top unit that also acts as a shelf.

**PRODUCTS USED:** 1 x 2018-6, 1 x 1138 & 2 x ERE6

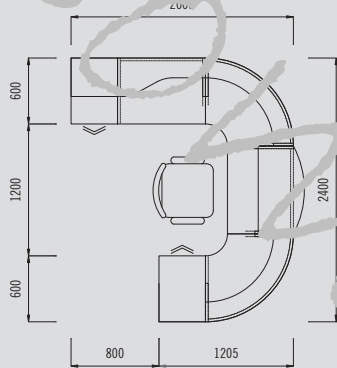

**ALTERNATIVE 2 - 600MM DEEP**

Even with a large footprint 'look' it is surprising that this proposal only requires a space of 2.4 x 2.005m excluding flow-space around the units.

This is a mere 4.43sqm and even with such a compact size, it offers all of Receptiv's grandeur, style and functionality.

New to this range is also a Desk Height Pedestal with the same depth of the base units as well as having adopted the same construction and look, for it to merge into the configuration unnoticed.

**PRODUCTS USED:** 1 x 2211, 1 x 2001-6, 1 x 2007-6, 1 x 2017-6, 1 x 2051-6, 1 x 1211, 2 x 1115, 1 x 1131, 1 x 1107 & 1 x 1214

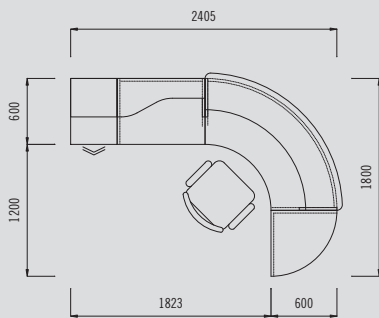

**ALTERNATIVE 3 - 600MM DEEP**

Here we have an L-Shape formation which is a very popular layout with the 800 deep base units with it requiring even less floor space.

Not only is the Desk Height Pedestal a base unit, but it can also accommodate a top unit to continue Receptiv's flowing lines.

A walled top unit creates a little flair to the overall look together with a shallow top unit that allows for good sight lines as well as storage space for the unsightly items.

**PRODUCTS USED:** 1 x 2211, 1 x 2001-6, 1 x 2052-6, 1 x 1138, 1 x 1107, 1 x 1214 & 1 x ERE6

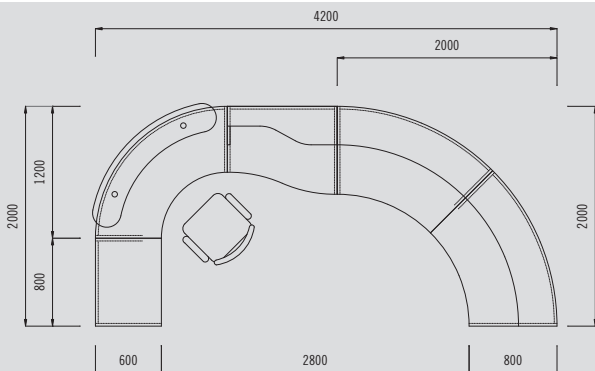

**ALTERNATIVE 4 - 600MM DEEP**

Now that we have both an 800 and 600 deep base unit on offer, we have given Receptiv the opportunity to migrate from a 800 deep configuration to a 600 deep configuration, all in one layout.

Naturally there are many other configurations available but this layout merely shows you how one can change from 800 to 600 deep base units (vice versa) with ease.

A clear or frosted glass shelf on the radius base unit allows Receptiv to have a more corporate, luxurious feel.

**PRODUCTS USED:** 1 x 2001-6, 1 x 3018-6, 1 x 2073, 1 x 2065-6, 1 x 2057-6, 1 x 1147, 1 x 1146, 1 x 1108 & 1 x 1308

**ALTERNATIVE 1**

Receptiv's 800 deep base and top units are already extensive in its entirety but we have yet added more options to make configurations more accommodating than before.

On this layout we have the new radius segment base unit which has a far more shallow inner radius for comfort and practicality. Flanked on either side of this unit we have the new segment base units and together this configuration makes up a useful 90° layout which fits perfectly into the corner of a room.

**PRODUCTS USED:** 2 x 1050, 2 x 2059 & 1 x 1065

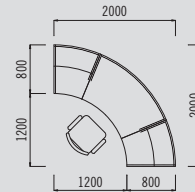

**ALTERNATIVE 2**

This layout shows off alternate configurations of the different radius units which can create a nice sweeping, creative flow of the reception outline.

These radius units come in a variety of angled ends starting with the original 90° option, then a 45°, 22°, 60° and 30° option. These alternatives give our CAD department more freedom for their space planning and designs. These options don't only apply to the base units but also include the top units.

**PRODUCTS USED:** 1 x 2057, 1 x 1147, 1 x 2066, 1 x 1015, 1 x 1018 & 1 x 1052

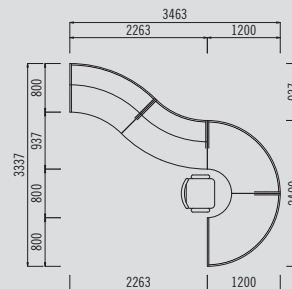

**ALTERNATIVE 3**

Another effective layout that fits nicely into a corner of a foyer or room. Even though these are 800 deep units with more working space surface, it is yet small and compact enough to fit into a 6.6m<sup>2</sup> floor area without difficulty.

Cut-back panel-end legs of the central units allow for free-flow leg room and offers a more user friendly working environment. Optional extras such as top units or shelves can be added to these base units.

**PRODUCTS USED:** 2 x 1057 & 1 x 1007

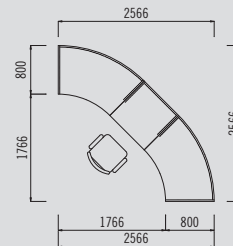

**ALTERNATIVE 4**

This compact yet stylish layout is created with both 90° and 45° base units. The central base unit offers a nice glass shelf option and the two units on either side offer the full height top units, ideal for concealing office stationary and creating a secure, private environment.

This layout is ideal for a central position of an entrance foyer. Note that, making use of different finishes to base and top units can create interesting visual appearances. We have a large library of finishes to choose from.

**PRODUCTS USED:** 2 x 2057, 2 x 1147, 1 x 3018 & 1 x 1308

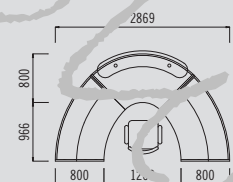

**ALTERNATIVE 5**

Here we have a central base unit which allows for wheelchair access and is compliant with the DDA requirements. On either side of this unit we have both the 22° and 22° inverted segment base units which create a shallow curved flow.

This configuration could perhaps fit into a wall opening of a corridor. Good stability of the individual base units is created by securing all base legs to one another with special securing bolts which are all provided in the kit.

**PRODUCTS USED:** 2 x 1059, 2 x 1068 & 1 x 1044

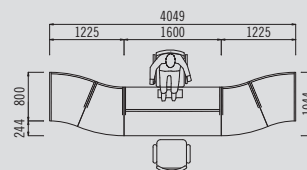

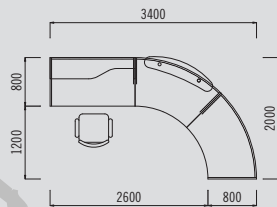
**ALTERNATIVE 6**

Here we have an L-Shape formation which is a very sought after layout and now possible with the addition of the new radius segments with their different angled ends. These radius segment units provide a more gentle curve.

A waved top unit creates a little flair to the overall look together with a shelf unit, whether frosted, clear glass or MFC board. Full panel ends to curved units are standard and no longer need to be specially ordered.

**PRODUCTS USED:** 1 x 1057, 1 x 3065, 1 x 1305, 1 x 2004 & 1 x 1110

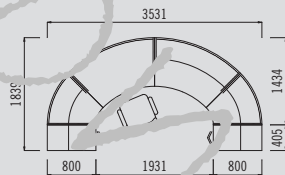
**ALTERNATIVE 7**

A balanced layout provides working space for one or two people. Two 45° radius base units, one with and one without a top unit offer a grand frontage.

Two 45° segment base units balance the reception out to 180° configuration. This is completed with two desk height pedestal base units each housing 2 shallow & 1 filling drawer. Top units to the pedestals are optional.

**PRODUCTS USED:** 2 x 2213, 2 x 1214, 2 x 2020, 2 x 1122, 1 x 1065, 1 x 2065 & 1 x 1146

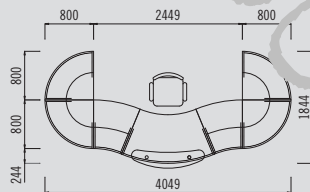
**ALTERNATIVE 8**

This curvaceous, luxurious balanced configurations with the centrally placed shallow radius base unit that accommodates a stylish glass shelf unit for signing documents in a comfortable standing position flanked with segment and 90 base units that include top units for privacy.

Combining your finishes of your base and top units to create that added touch. Altogether an impressive display when entering the foyer of a corporate company.

**PRODUCTS USED:** 2 x 2051, 2 x 2017, 2 x 2068, 1 x 3065, 1 x 1305, 2 x 1151 & 4 x 1118

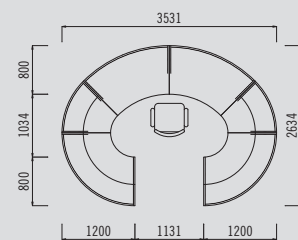
**ALTERNATIVE 9**

Almost elliptical in shape and virtually enclosed and yet allowing plenty of manoeuvrability and working space within the area.

This configuration is made up of two 45° radius segment base units flanked with two 45° segment and 90° corner units. All secured to one another they provide a solid uniform presence. By adding top units to the rear and sides offers more privacy. The larger radius top units come with a in situ shelf option.

**PRODUCTS USED:** 2 x 2052, 2 x 2020, 2 x 1065, 2 x 1122 & 2 x 1117

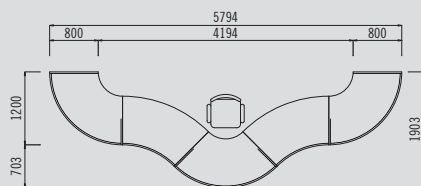
**ALTERNATIVE 10**

Today more emphasis is placed on curves and interesting shapes. Here we are merely showing you the effects that can be achieved with the variety of the new curved units, both standard and inverted.

The inverted base units are supported with one central steel leg for stability. Plenty of space under the base units allow for accessories such as mobile pedestals and storage units. Full panel end legs to curved units are standard and no longer need to be specially ordered.

**PRODUCTS USED:** 2 x 1052, 2 x 1066 & 1 x 1021